

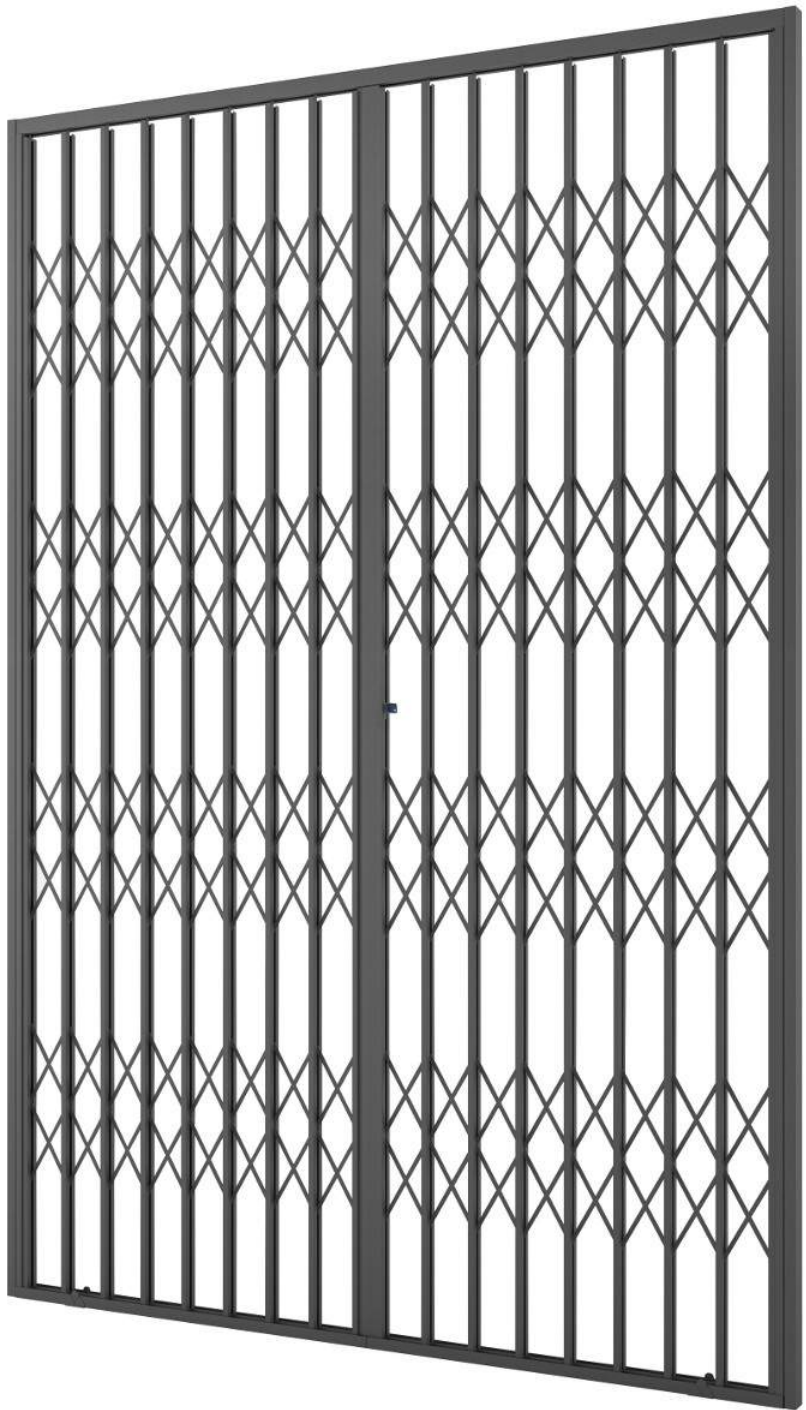

**inferriate.it**  
MASSIMA SICUREZZA AL MINOR PREZZO

# SCHEMA TECNICA EXTEN

aggiornato al 1/4/2018



**inferriate.it**  
MASSIMA SICUREZZA AL MINOR PREZZO

## **Mod. EXTEN**

Certificato Classe 2 e 3



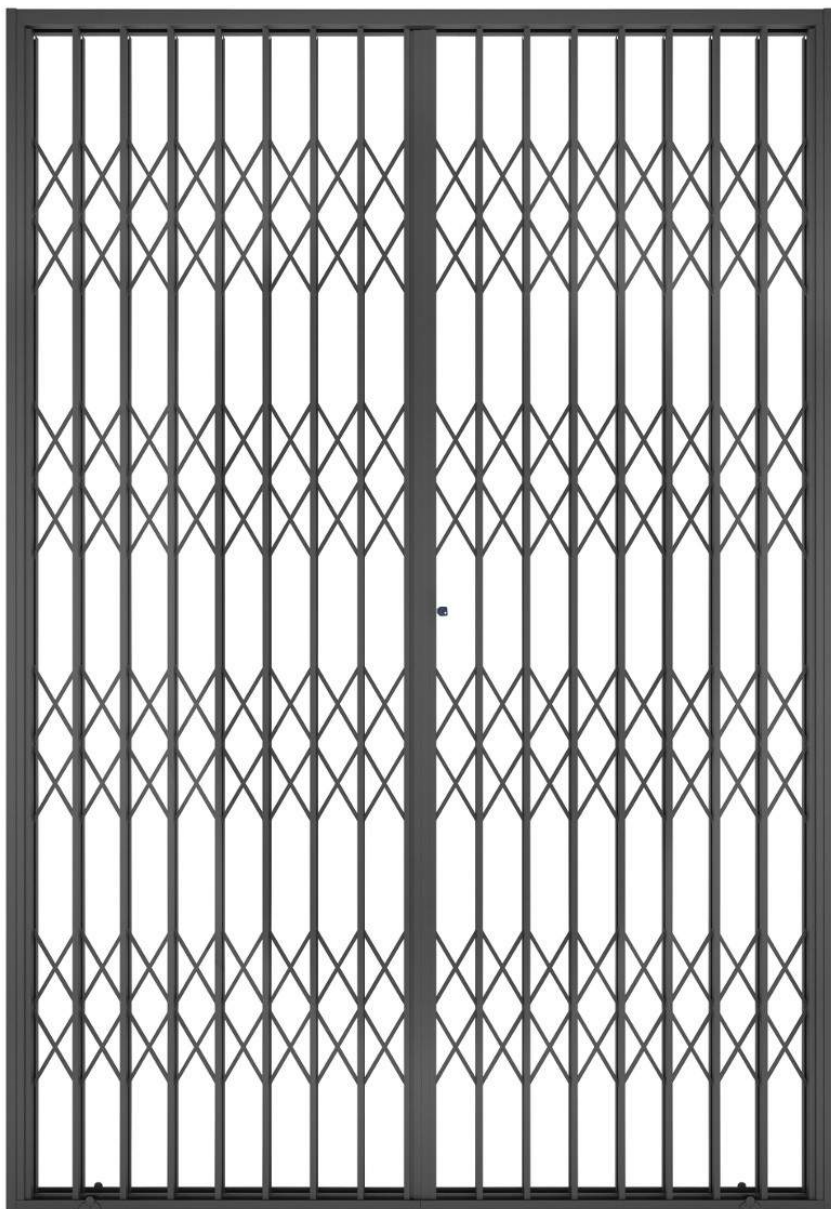

**inferriate.it**  
MASSIMA SICUREZZA AL MINOR PREZZO

Cancello estensibile realizzato interamente in acciaio zincato, senza saldature, con marcatura CE secondo la Norma EN 13241-1 e Certificato Classe 2 e 3

- Profili verticali ad "U" 15x15x15 spessore 12/10 (oppure 20/10 nella versione Classe 3)
- Pantografo a "X" semplice nella versione Classe 2 (doppio pantografo nella versione Classe 3)
- Carrelli scorrevoli appesi su cuscinetti a sfera
- Serratura a cilindro Prefer con chiavi unificate a 2 punti di chiusura (3 punti di chiusura nella versione "Serratura Rinforzata")
- "C" di tamponamento laterale per fissaggio a muro
- Guida inferiore antistrappo ad "omega"
- Scorrimento tramite cuscinetti a sfere in guida da 45x40 mm
- Viti di fissaggio con tassello in nylon da 40x8 mm

Se richiesto, il cancello viene verniciato a polvere poliestere termoindurente.  
Garanzia 10 anni.

A richiesta il cancello può avere:

- Raccolte asimmetriche
- Guida inferiore alzabile
- Raccolta girevole 180°
- Montaggio ad incasso

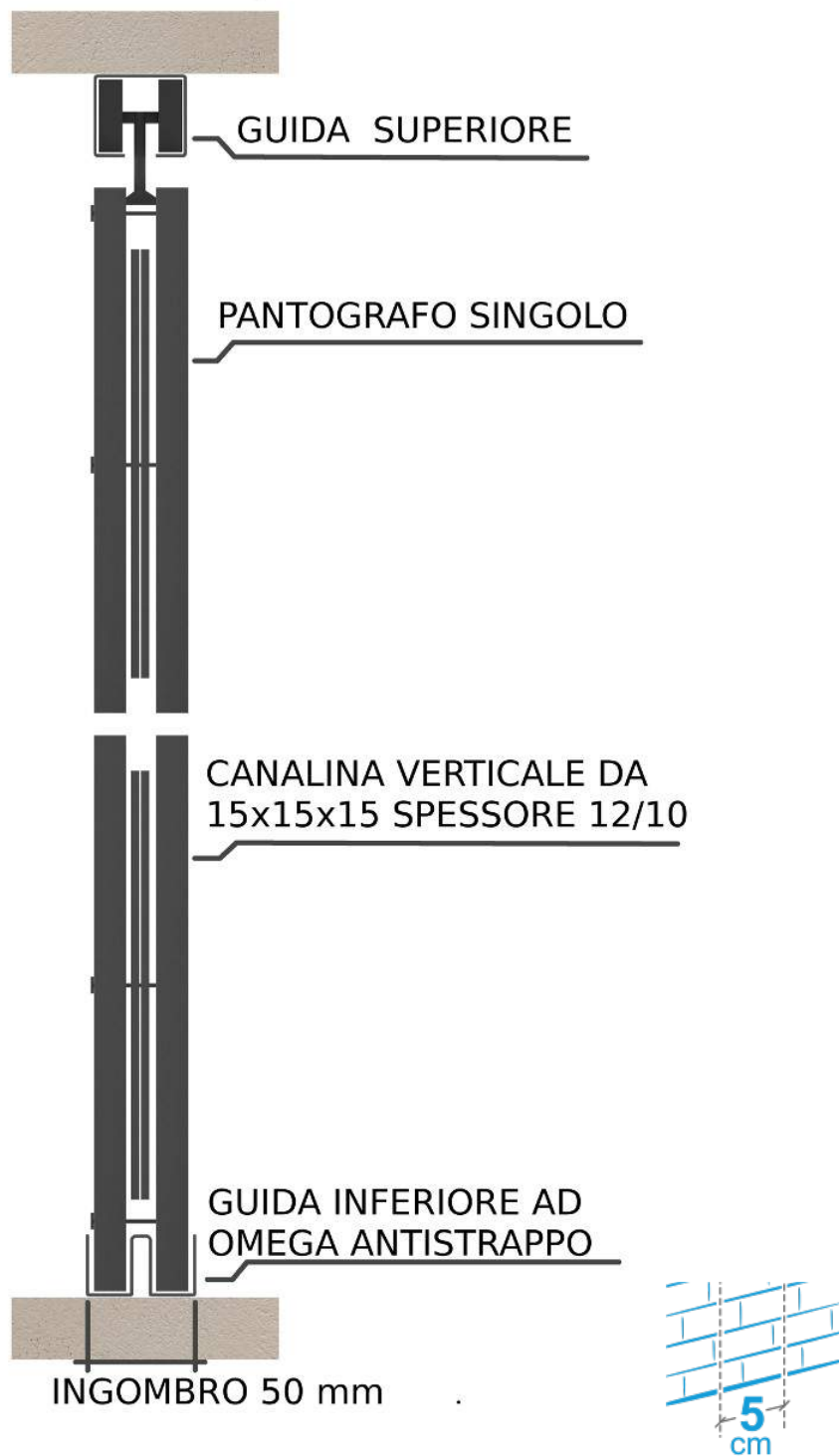

**inferriate.it**  
 MASSIMA SICUREZZA AL MINOR PREZZO

## Mod. EXTEN

Sezione verticale

**Versione Classe 2**



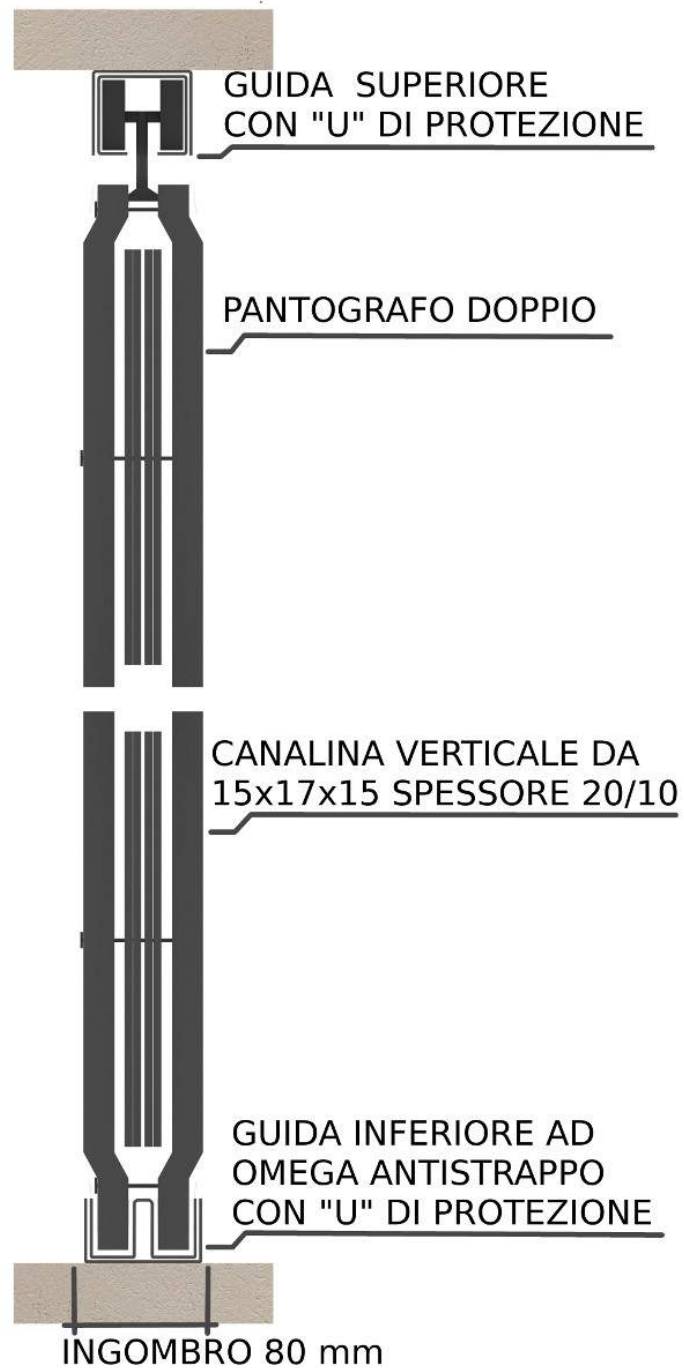

## Mod. EXTEN

Sezione verticale

**Versione Classe 3**





**inferriate.it**  
MASSIMA SICUREZZA AL MINOR PREZZO

VERSIONE CLASSE 2

RISCONTRO LATERALE

PROFILO DI FISSAGGIO  
LATERALE A "C"

VERSIONE CLASSE 3

RISCONTRO LATERALE  
CON TUBOLARE INTERNO  
DI RINFORZO

## Mod. EXTEN

Sezione orizzontale

**Versione Classe 2 e 3**

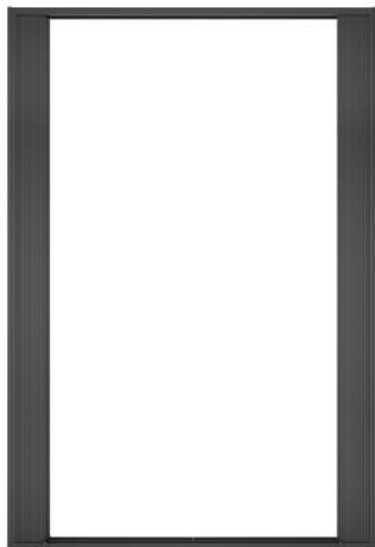

Larghezza Luce Finestra	Ingombro singola raccolta	Ingombro raccolta doppia
50	10,5	-
60	12,0	-
70	13,5	-
80	15,0	
100	18,0	12,0 - 12,0
120	19,5	12,0 - 12,0
140	22,5	13,5 - 13,5
150	23,5	13,8 - 13,8
200	30,0	17,0 - 17,0
250	36,0	20,5 - 20,5
300	42,7	23,5 - 23,5
350	49,0	26,8 - 26,8
400	55,0	30,0 - 30,0
450	61,0	33,0 - 33,0
500	67,0	36,0 - 36,0
550	73,0	39,5 - 39,5
600	79,0	42,7 - 42,7

## Mod. EXTEN

Ingombri raccolte

Misure espresse in CM



E' possibile richiedere delle zanche di fissaggio per montaggio ad incasso.  
Nella figura sotto esempio di fissaggio con zanche a Z

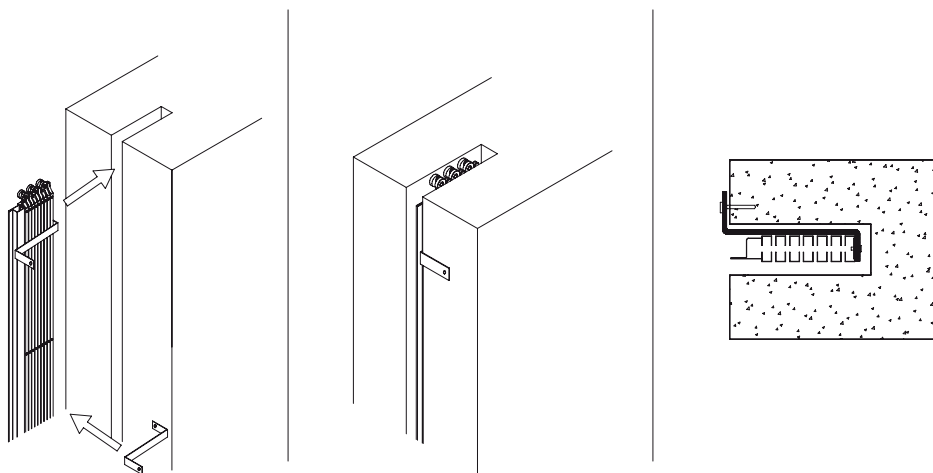

Un altro sistema di fissaggio può essere realizzato con cassetto in lamiera da murare con cancelletto pre-inserito

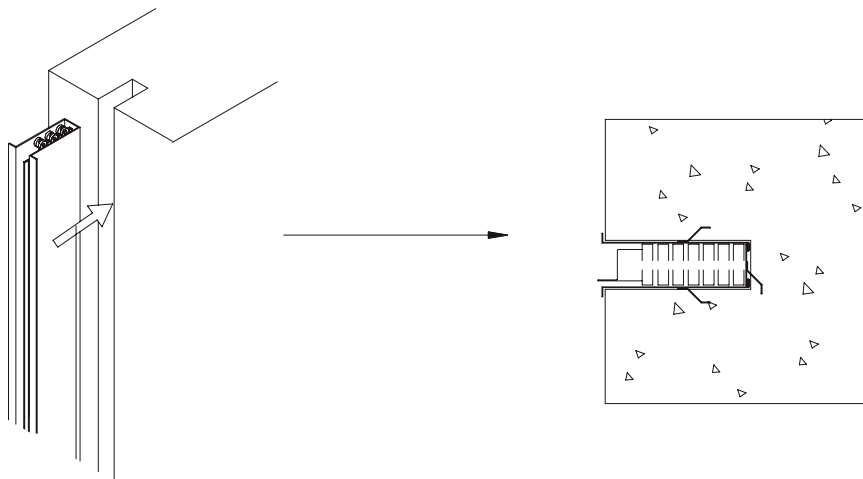

**inferriate.it**  
MASSIMA SICUREZZA AL MINOR PREZZO

## Mod. EXTEN

Installazione ad incasso





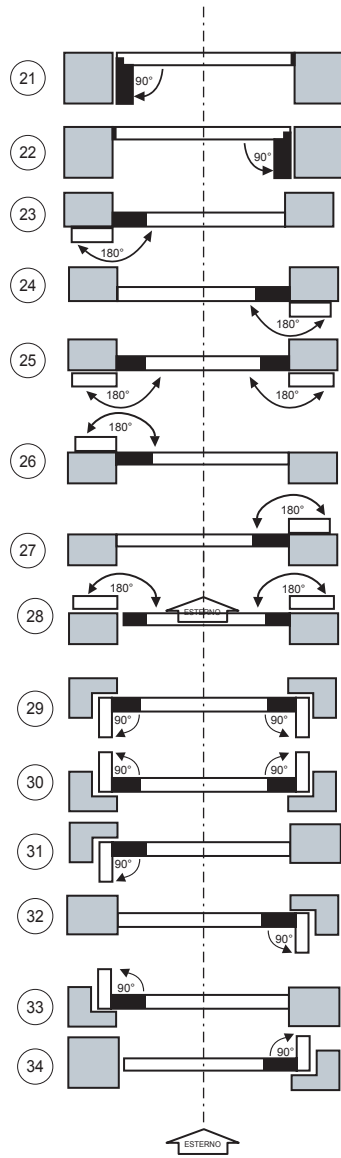
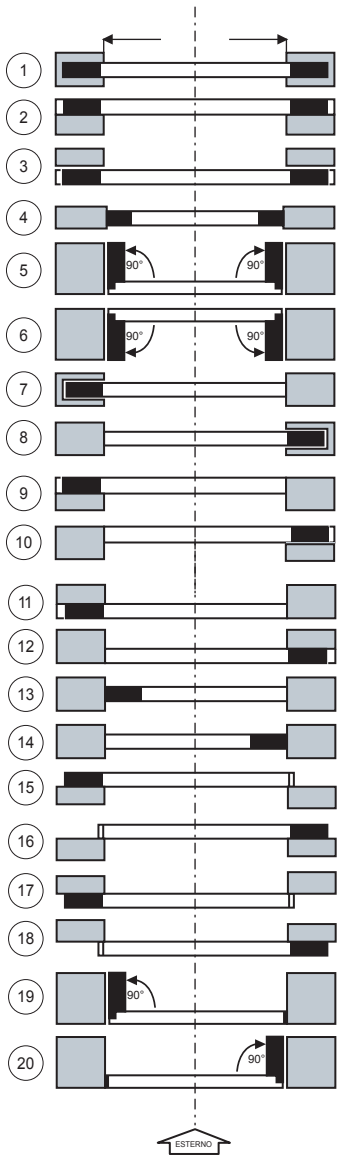
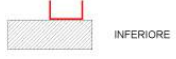

**inferriate.it**  
 MASSIMA SICUREZZA AL MINOR PREZZO

# Mod. EXTEN

Tavola installazioni





Exten è l'inferriata estensibile in acciaio su misura, il giusto compromesso tra sicurezza e qualità, robusta ed elegante lascerà trascorrere serenamente le giornate rendendo inviolabile la vostra casa.

Exten è alla portata di chiunque perché non richiede opere murarie, ma si installa con semplici tasselli sia su porte che finestre. L'applicazione di Exten non ostruisce il passaggio della luce, grazie al suo impacchettamento laterale.

E' un prodotto Made in Italy certificato in classe 2 e 3 anti-effrazione presso l'ente certificatore CSI.



[www.inferriate.it](http://www.inferriate.it)

Prodotto Certificato Antieffrazione





# inferriate.it

MASSIMA SICUREZZA AL MINOR PREZZO

Dove Siamo  
02 40326001  
[info@inferriate.it](mailto:info@inferriate.it)  
P.iva 10580040961



## FACEBOOK

Diventa Fan della nostra pagina e condividi con i tuoi amici i nostri post



## TWITTER

Twitta per noi e con noi diffondendo la sicurezza tra i Social



## GOOGLE PLUS

Entra a far parte delle nostre cerchie e usufruisci delle funzionalità Google



## YOUTUBE

Visiona i video della nostra playlist ed acculturati in materia di sicurezza